

### Raspberry Pi Pico

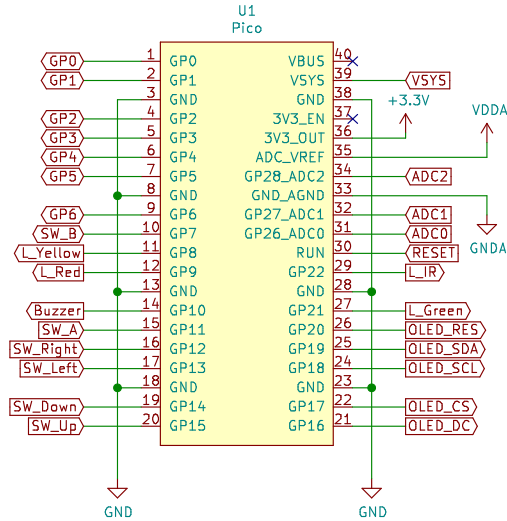

### SSD1309 OLED Screen

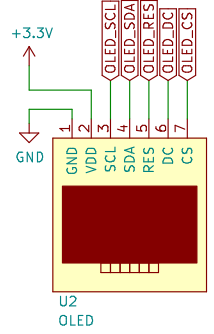

### Battery

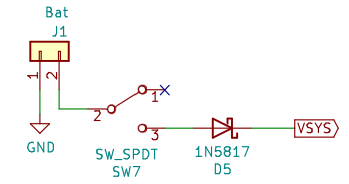

### LDR

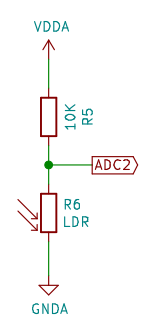

### GPIO

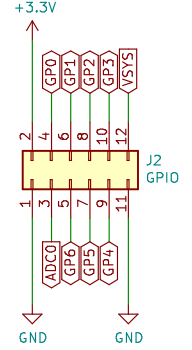

### D-Pad

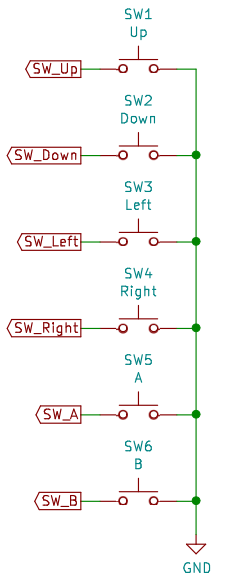

### LEDs

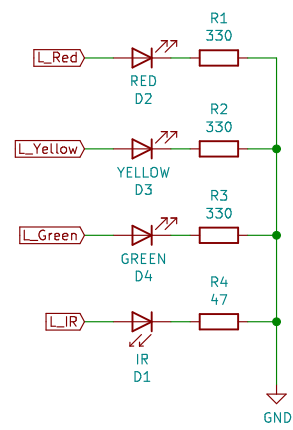

### Potentiometer

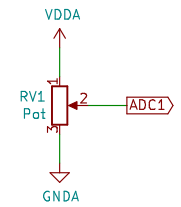

### Buzzer

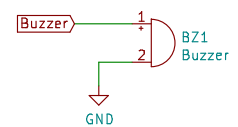

### Reset

